



## Features

- High voltage output (115/230/380V)
- Fanless and conduction-cooled design
- Slim and 1U Low profile (41mm)
- Built-in active PFC function
- DC 12V/0.4A auxiliary available
- Output voltage and constant current level programmable(PV/PC)
- Protections: Short circuit / Over load / Over voltage / Over temperature
- Built-in remote ON-OFF control and DC OK signal
- Operating altitude up to 2000 meter (E type Note.6, Blank/PM/CAN type Note.7)
- LED indicator for power on
- Optional PMBus or CANBus protocol
- 5 years warranty

## Description

UHP-1500 series is a 1500W single-output slim type power supply with 1U 41mm of low profile design. Adopting the full range 90~264VAC input, the entire series provides an output voltage line of 115V and 230V and 380V. In addition to the high efficiency up to 95.5%, that the whole series operates from -30°C ~ 70°C under air convection without fan. UHP-1500 has the complete protection functions and 5G anti-vibration capability; It is complied with the international safety regulations such as TUV BS EN/EN62368-1, UL62368-1, and the design refers to BS EN/EN61558-1 and BS EN/EN60335-1. UHP-1500 series serves as a high performance power supply solution for various industrial and DC centralized bus applications.

## Model Encoding

UHP - 1500 - 380 □

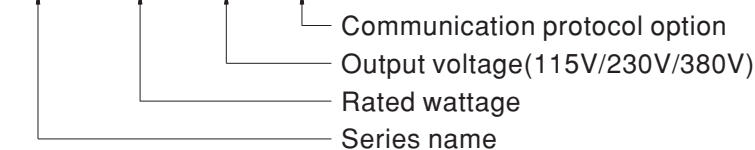

Type	Communication Protocol	Note
Blank	with programming PV/PC	In Stock
E	DC 380V only without PV/PC	In Stock
PM	PMBus protocol with PV/PC	By request
CAN	CANBus protocol with PV/PC	By request

Note: E type without PV/PC and communication protocol.

## Applications

- Industrial automation machinery
- Industrial control system
- Mechanical and electrical equipment
- Electronic instruments, equipment or apparatus
- Test and measurement instrument
- Laser related machine
- Charging related equipment
- DC centralized bus(Lighting)



**SPECIFICATION ( E type )**

MODEL	UHP-1500-380E			
OUTPUT	DC VOLTAGE(DEFAULT)	380V		
	RATED CURRENT (Max.)	3.95A		
	RATED POWER (Max.)(Note.7)	1501W		
	RIPPLE & NOISE (Max.) Note.2	3800mVp-p		
	VOLTAGE ADJ. RANGE	By built-in potentiometer, SVR 350~420V		
	VOLTAGE TOLERANCE Note.3	±1.0%		
	LINE REGULATION	±0.5%		
	LOAD REGULATION	±0.5%		
	SETUP, RISE TIME	1800ms, 60ms/230VAC at full load		
	HOLD UP TIME (Typ.)	16ms/230VAC at 75% load    10ms/230VAC at full load		
INPUT	VOLTAGE RANGE Note.4	90 ~ 264VAC    250 ~ 370VDC		
	FREQUENCY RANGE	47 ~ 63Hz		
	POWER FACTOR (Typ.)	PF ≥ 0.95/230VAC    at full load		
	EFFICIENCY (Typ.)	95.5%		
	AC CURRENT (Typ.)	8A/230VAC		
	INRUSH CURRENT (Typ.)	Cold start 60A/230VAC		
PROTECTION	OVER LOAD	105~125% rated output power Protection type : Constant current limiting, unit will shutdown after 2-5 sec, re-power on to recover.		
	SHORT CIRCUIT	Constant current limiting, unit will shutdown after 2-5 sec, re-power on to recover.		
	OVER VOLTAGE	420 ~ 460V Protection type : Shut down O/P voltage, re-power on to recover		
	OVER TEMPERATURE	Protection type : Shut down O/P voltage, recovers automatically after temperature goes down		
	FUNCTION	REMOTE ON/OFF CONTROL	Power ON : Short circuit    Power OFF : Open circuit	
ENVIRONMENT	WORKING TEMP.	-30 ~ +70°C (Refer to "Derating Curve")		
	WORKING HUMIDITY	20 ~ 90% RH non-condensing		
	STORAGE TEMP., HUMIDITY	-40 ~ +85°C, 10 ~ 95% RH non-condensing		
	TEMP. COEFFICIENT	±0.03%/°C (0 ~ 50°C)		
	VIBRATION	10 ~ 500Hz, 5G 10min./1cycle, 60min. each along X, Y, Z axes		
SAFETY & EMC (Note.6)	SAFETY STANDARDS	UL62368-1, TUV BS EN/EN62368-1, EAC TP TC 004 approved; Design refers to BS EN/EN61558-1, BS EN/EN60335-1		
	WITHSTAND VOLTAGE Note.8	I/P-O/P:6KVDC    I/P-FG:4KVDC    O/P-FG:4KVDC		
	ISOLATION RESISTANCE	I/P-O/P, I/P-FG, O/P-FG:100M Ohms/500VDC/25°C / 70%RH		
	EMC EMISSION	Parameter	Standard	Test Level / Note
		Conducted	BS EN/EN55032 (CISPR32)	Class B
		Radiated	BS EN/EN55032 (CISPR32)	Class A
		Harmonic Current	BS EN/EN61000-3-2	Class A
		Voltage Flicker	BS EN/EN61000-3-3	-----
	EMC IMMUNITY	Parameter	Standard	Test Level / Note
		ESD	BS EN/EN61000-4-2	Level 3, 8KV air ; Level 2, 4KV contact
		Radiated	BS EN/EN61000-4-3	Level 3
		EFT / Burst	BS EN/EN61000-4-4	Level 3
		Surge	BS EN/EN61000-6-2	2KV/Line-Line 4KV/Line-Earth
Conducted		BS EN/EN61000-4-6	Level 3	
Magnetic Field		BS EN/EN61000-4-8	Level 4	
Voltage Dips and Interruptions		BS EN/EN61000-4-11	>95% dip 0.5 periods, 30% dip 25 periods, >95% interruptions 250 periods	
OTHERS	MTBF	181.47K hrs min.    Telcordia SR-332 (Bellcore) ; 56.72K hrs min.    MIL-HDBK-217F (25°C)		
	DIMENSION	290*140*41mm (L*W*H)		
	PACKING	2.51kg ; 6pcs/16.06kg/0.86CUFT		
NOTE	<p>1. All parameters NOT specially mentioned are measured at 230VAC input, rated load and 25°C of ambient temperature.</p> <p>2. Ripple &amp; noise are measured at 20MHz of bandwidth by using a 12" twisted pair-wire terminated with a 0.1uf &amp; 47uf parallel capacitor.</p> <p>3. Tolerance : includes set up tolerance, line regulation and load regulation.</p> <p>4. Derating may be needed under low input voltages. Please check the derating curve for more details.</p> <p>5. The power supply is considered a component which will be installed into a final equipment. All the EMC tests are been executed by mounting the unit on a 720mm*360mm metal plate with 1mm of thickness. The final equipment must be re-confirmed that it still meets EMC directives. For guidance on how to perform these EMC tests, please refer to "EMI testing of component power supplies." (as available on <a href="http://www.meanwell.com">http://www.meanwell.com</a>)</p> <p>6. The ambient temperature derating of 3.5°C/1000m with fanless models and of 5°C/1000m with fan models for operating altitude higher than 2000m(6500ft).</p> <p>7. Refer to derating curve.</p> <p>8. To avoid damage to components or insulations that are not involved in the test, ICs or the like, may be disconnected and equipotential bonding may be used. A varistor complying with clause G.8 may be removed during the test.</p> <p>※ Product Liability Disclaimer : For detailed information, please refer to <a href="https://www.meanwell.com/serviceDisclaimer.aspx">https://www.meanwell.com/serviceDisclaimer.aspx</a></p>			

## SPECIFICATION (Blank/PM/CAN type)

MODEL		UHP-1500-115 <input type="checkbox"/>	UHP-1500-230 <input type="checkbox"/>	UHP-1500-380 <input type="checkbox"/>	
OUTPUT	DC VOLTAGE(DEFAULT)	115V	230V	380V	
	CURRENT (FACTORY DEFAULT)	13.05A	6.52A	3.95A	
	RATED CURRENT (Max.)	13.05A	6.95A	4.5A	
	POWER (FACTORY DEFAULT)	1500.75W	1500W	1500W	
	RATED POWER (Max.)(Note.8)	1500.75W	1501.2W	1503W	
	RIPPLE & NOISE (Max.) Note.2	1150mVp-p	2300mVp-p	3800mVp-p	
	FULL POWER VOLTAGE RANGE	115~138V	216~260V	334~400V	
	VOLTAGE ADJ. RANGE	By built-in potentiometer, SVR			
		90~138V	170~260V	260~400V	
	VOLTAGE TOLERANCE Note.3	±1.0%	±1.0%	±1.0%	
	LINE REGULATION	±0.5%	±0.5%	±0.5%	
LOAD REGULATION	±0.5%	±0.5%	±0.5%		
SETUP, RISE TIME	1800ms, 60ms/230VAC at full load				
HOLD UP TIME (Typ.)	16ms/230VAC at 75% load 10ms/230VAC at full load				
INPUT	VOLTAGE RANGE Note.4	90 ~ 264VAC 250 ~ 370VDC			
	FREQUENCY RANGE	47 ~ 63Hz			
	POWER FACTOR (Typ.)	PF ≥0.95/230VAC at full load			
	EFFICIENCY (Typ.)	95%	95%	95.5%	
	AC CURRENT (Typ.)	8A/230VAC			
	INRUSH CURRENT (Typ.)	Cold start 60A/230VAC			
	LEAKAGE CURRENT	<0.75mA / 240VAC			
PROTECTION	OVER LOAD	105~125% rated output power Protection type : Constant current limiting, unit will shutdown after 5 sec, re-power on to recover.			
	SHORT CIRCUIT	Constant current limiting, unit will shutdown after 5 sec, re-power on to recover.			
	OVER VOLTAGE	145 ~175V	273 ~ 325V	420 ~ 460V	
		Protection type : Shut down O/P voltage, re-power on to recover			
	OVER TEMPERATURE	Protection type : Shut down O/P voltage, recovers automatically after temperature goes down			
FUNCTION	OUTPUT VOLTAGE PROGRAMMABLE(PV) Note 5	Adjustment of output voltage is allowable to 50 ~ 120% of nominal output voltage Please refer to the Function Manual.			
	OUTPUT CURRENT PROGRAMMABLE(PC) Note 5	Adjustment of constant current level is allowable to 20 ~ 100% of rated current. Please refer to the Function Manual.			
	REMOTE ON/OFF CONTROL	Power ON : Short circuit Power OFF : Open circuit			
	AUXILIARY POWER	12V @ 0.4A tolerance ±10%, ripple=150mVp-p			
	DC-OK SIGNAL	The TTL signal out, PSU turn on = 4.4 ~ 5.5V ; PSU turn off = -0.5 ~ 0.5V. Please refer to the Function Manual.			
ENVIRONMENT	WORKING TEMP.	-30 ~ +70°C (Refer to "Derating Curve")			
	WORKING HUMIDITY	20 ~ 90% RH non-condensing			
	STORAGE TEMP., HUMIDITY	-40 ~ +85°C, 10 ~ 95% RH non-condensing			
	TEMP. COEFFICIENT	±0.03%/°C (0 ~ 50°C)			
	VIBRATION	10 ~ 500Hz, 5G 10min./1cycle, 60min. each along X, Y, Z axes			
SAFETY & EMC (Note.6)	SAFETY STANDARDS	UL62368-1,TUV BS EN/EN62368-1, EAC TP TC 004 approved; Design refers to BS EN/EN61558-1, BS EN/EN60335-1			
	WITHSTAND VOLTAGE Note 9	I/P-O/P:6KVDC I/P-FG:4KVDC O/P-FG:4KVDC			
	ISOLATION RESISTANCE	I/P-O/P, I/P-FG,O/P-FG:100M Ohms/500VDC/25°C / 70%RH			
	EMC EMISSION	Parameter	Standard	Test Level / Note	
		Conducted	BS EN/EN55032 (CISPR32)	Class B	
		Radiated	BS EN/EN55032 (CISPR32)	Class A	
		Harmonic Current	BS EN/EN61000-3-2	Class A	
		Voltage Flicker	BS EN/EN61000-3-3	-----	
	EMC IMMUNITY	BS EN/EN55035 , BS EN/EN61000-6-2			
		Parameter	Standard	Test Level / Note	
		ESD	BS EN/EN61000-4-2	Level 3, 8KV air ; Level 2, 4KV contact	
Radiated		BS EN/EN61000-4-3	Level 3		
EFT / Burst		BS EN/EN61000-4-4	Level 3		
Surge		BS EN/EN61000-6-2	2KV/Line-Line 4KV/Line-Earth		
Conducted		BS EN/EN61000-4-6	Level 3		
Magnetic Field		BS EN/EN61000-4-8	Level 4		
Voltage Dips and Interruptions	BS EN/EN61000-4-11	>95% dip 0.5 periods, 30% dip 25 periods, >95% interruptions 250 periods			
OTHERS	MTBF	181.47K hrs min. Telcordia SR-332 (Bellcore) ; 56.72K hrs min. MIL-HDBK-217F (25°C)			
	DIMENSION	290*140*41mm (L*W*H)			
	PACKING	2.51kg ; 6pcs/16.06kg/0.86CUFT			

**NOTE**

- All parameters NOT specially mentioned are measured at 230VAC input, rated load and 25°C of ambient temperature.
- Ripple & noise are measured at 20MHz of bandwidth by using a 12" twisted pair-wire terminated with a 0.1uF & 47uF parallel capacitor.
- Tolerance : includes set up tolerance, line regulation and load regulation.
- Derating may be needed under low input voltages. Please check the derating curve for more details.
- PV/PC functions when users do not use SVR.
- The power supply is considered a component which will be installed into a final equipment. All the EMC tests are been executed by mounting the unit on a 720mm\*360mm metal plate with 1mm of thickness. The final equipment must be re-confirmed that it still meets EMC directives. For guidance on how to perform these EMC tests, please refer to "EMI testing of component power supplies." (as available on <http://www.meanwell.com>)
- The ambient temperature derating of 3.5°C/1000m with fanless models and of 5°C/1000m with fan models for operating altitude higher than 2000m(6500ft).
- Refer to derating curve.
- To avoid damage to components or insulations that are not involved in the test, ICs or the like, may be disconnected and equipotential bonding may be used. A varistor complying with clause G.8 may be removed during the test.

※ Product Liability Disclaimer : For detailed information, please refer to <https://www.meanwell.com/serviceDisclaimer.aspx>

## ■ BLOCK DIAGRAM

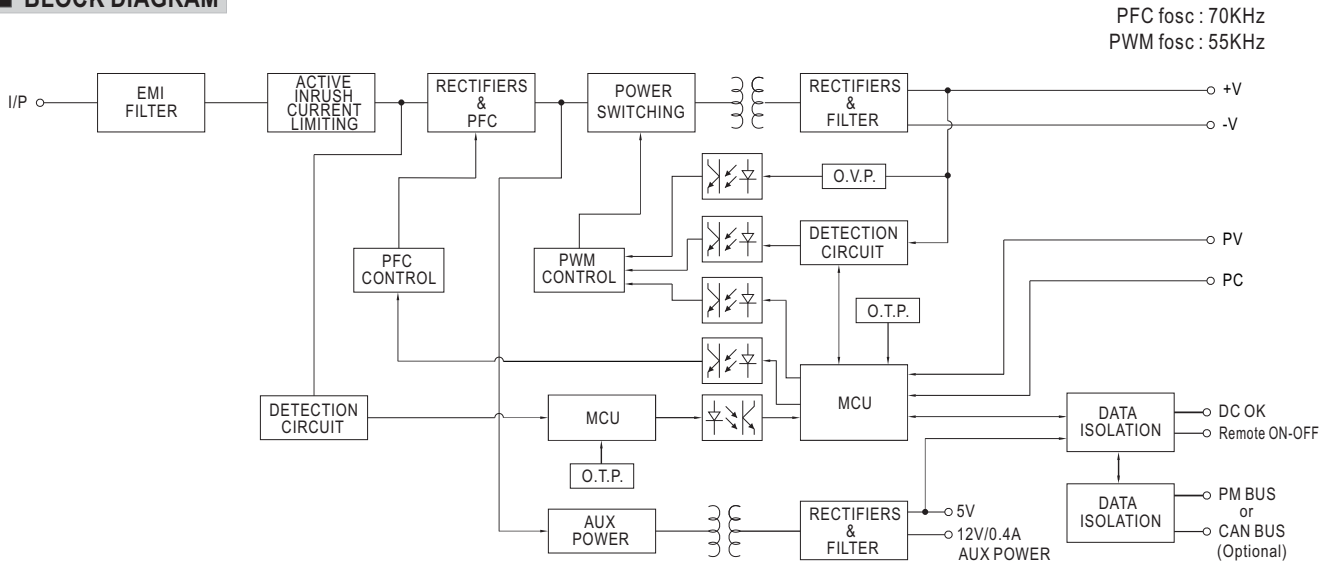

## ■ STATIC CHARACTERISTIC

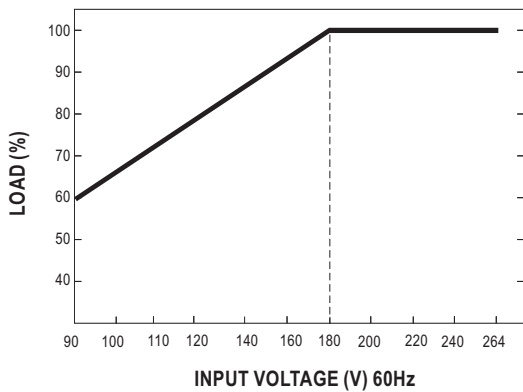

## ■ EFFICIENCY VS LOAD (380V MODEL)

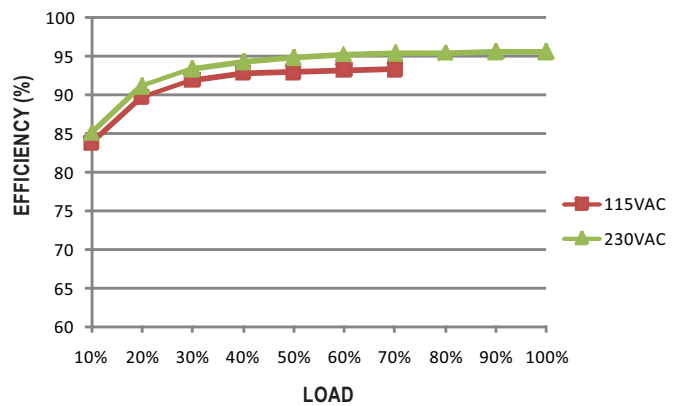

## ■ DERATING CURVE

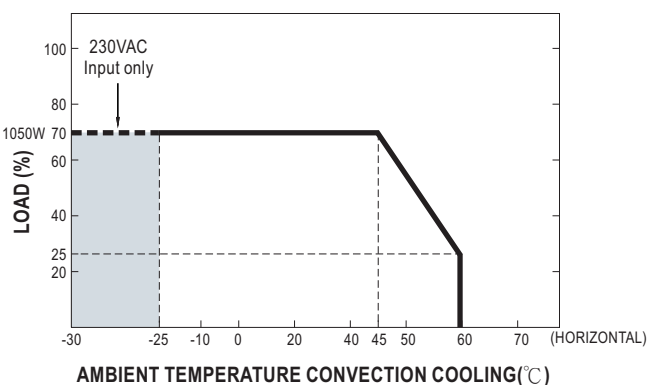
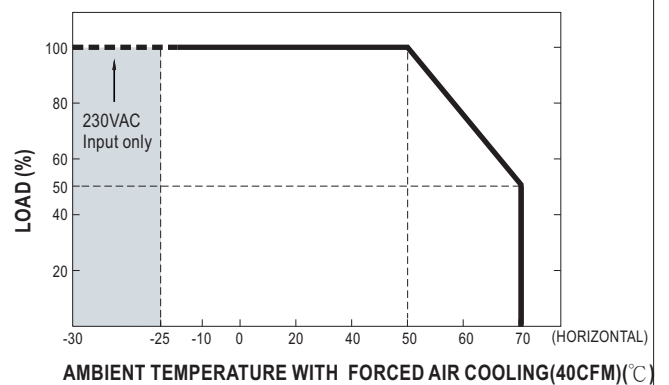
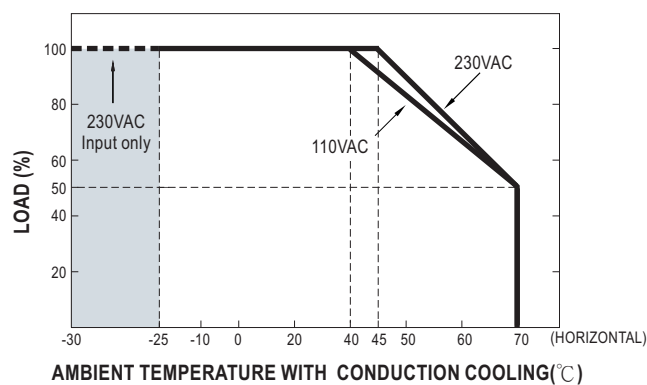

## FUNCTION MANUAL ( For E type)

### 1. Output Voltage

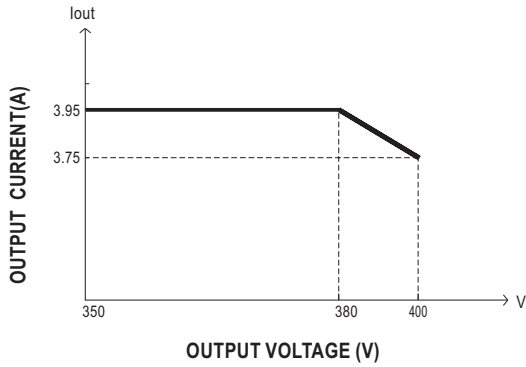

### 2. Remote ON-OFF Control

The power supply can be turned ON/OFF individually or along with other units in parallel by using the "Remote ON-OFF" function.

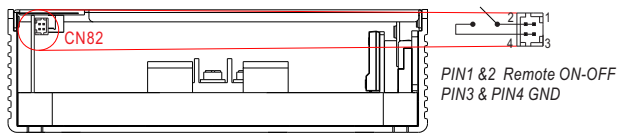

Remote ON-OFF	Power Supply Status
Short circuit	ON
Open circuit	OFF

## FUNCTION MANUAL (Blank/PM/CAN type)

### 1. Output Voltage Programming (or, PV / remote voltage programming / remote adjust / margin programming / dynamic voltage trim)

- ※ In addition to the adjustment via the built-in potentiometer, the output voltage can be trimmed to 50%~120% by applying EXTERNAL VOLTAGE.
- ※ When PC/PV are used at the same time, PC is preferred

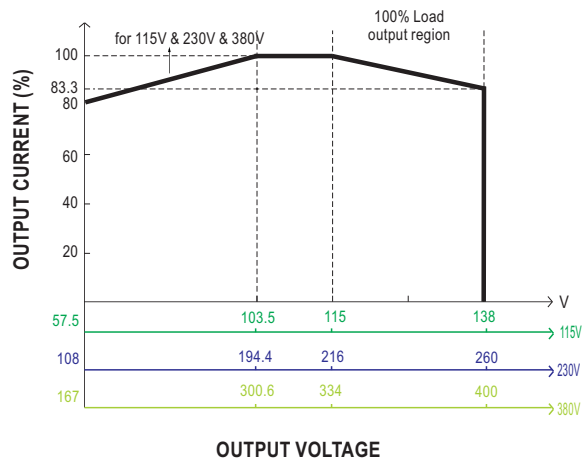
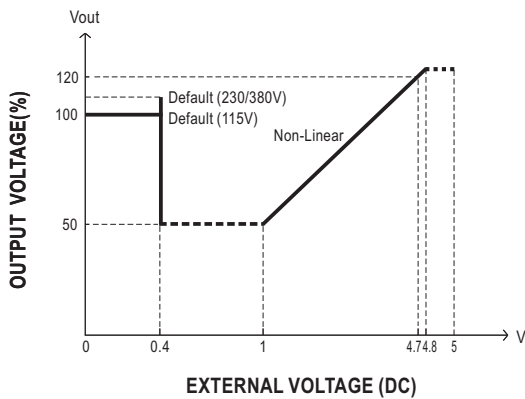
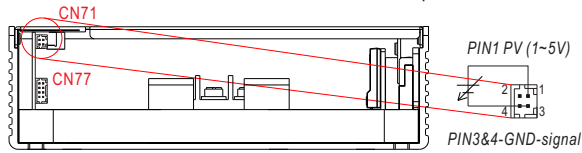

◎The rated current should change with the Output Voltage Programming accordingly

### 2. Constant Current Programming (or, PC / remote current programming / dynamic current trim)

- ※ The output current can be trimmed to 20~100% of the rated current by applying EXTERNAL VOLTAGE.

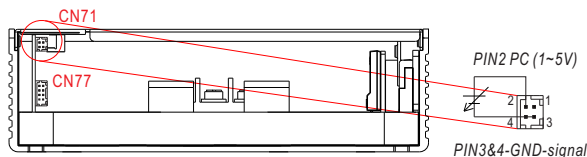

◎ Covered by over temperature protection auto de-rating function works under operation either in PC mode or under control by communication protocol.

T<sub>1</sub>(Typ.): Maximum ambient temperature of full load.

T<sub>2</sub>(Typ.): T<sub>1</sub>+5°C.

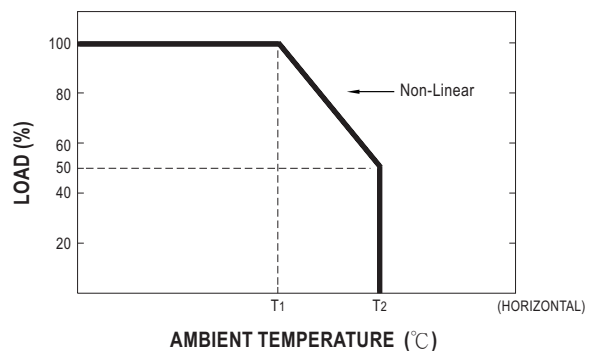
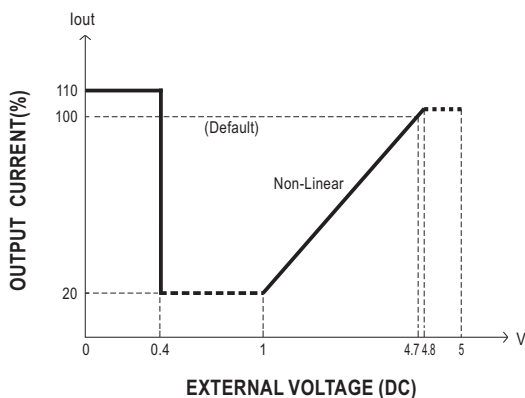

### 3. Remote ON-OFF Control

The power supply can be turned ON/OFF individually or along with other units in parallel by using the "Remote ON-OFF" function.

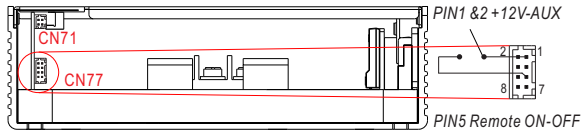

Remote ON-OFF	Power Supply Status
Short circuit	ON
Open circuit	OFF

### 4. DC-OK Signal

DC-OK signal is a TTL level signal. The maximum sink current is 10mA and the maximum external voltage is 5.6V.

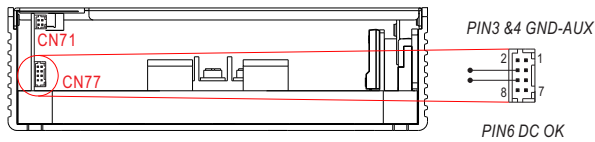

DC-OK signal	Power Supply Status
"High" >4.4~5.5V	ON
"Low" <-0.5~0.5V	OFF

### 5. PMBus Communication Interface

UHP-1500 supports PMBus Rev. 1.1 with maximum 100KHz bus speed, allowing information reading, status monitoring, output trimming, etc. For details, please refer to the Function Manual.

**MECHANICAL SPECIFICATION (For E type)**

Case No.277A

Unit:mm

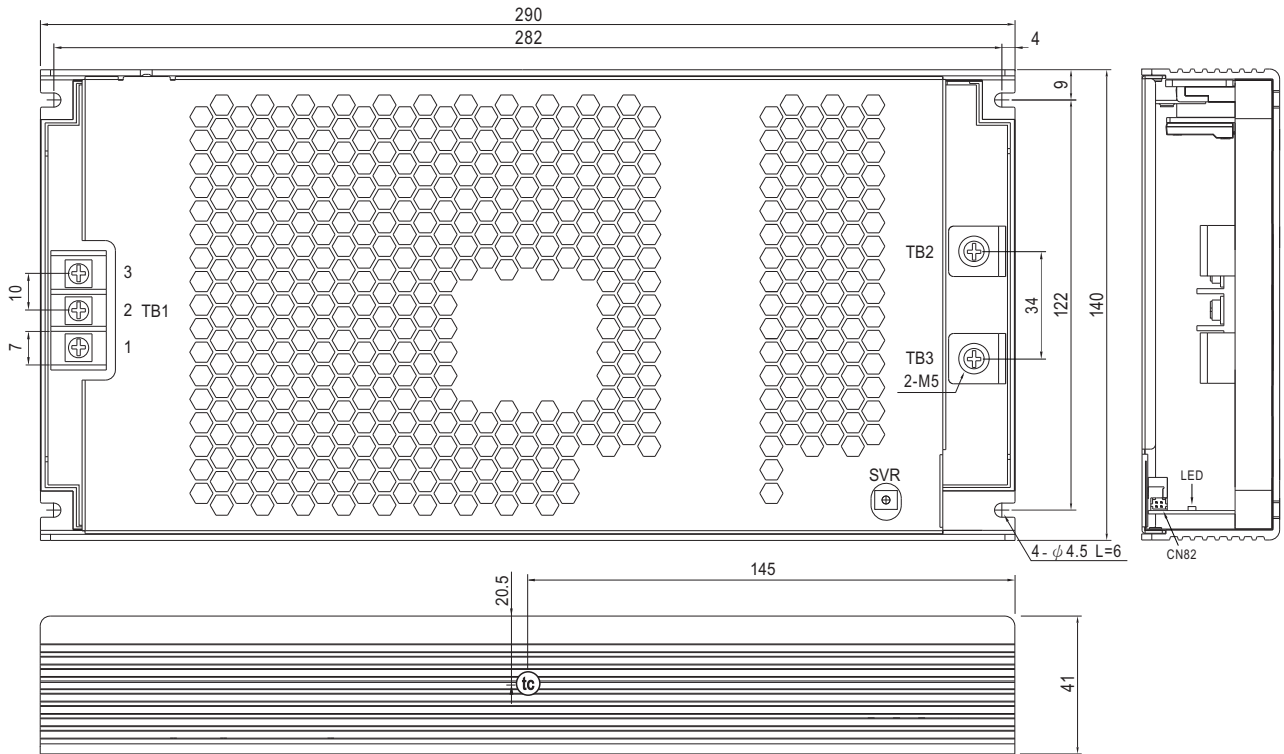

• (tc) : Max. Case Temperature

AC Input Terminal(TB1) Pin NO. Assignment

Pin No.	Assignment	Terminal	Max mounting torque
1	AC/L	DG58S	18Kgf-cm
2	AC/N		
3	⏏		

DC Output Terminal(TB2, TB3) Pin NO. Assignment

Pin No.	Assignment	Terminal	Max mounting torque
TB2	+V	(MW)	8Kgf-cm
TB3	-V	HS455A	

※Control Pin No. Assignment(CN82) : HRS DF11-04DP-2DS or equivalent

Pin No.	Function	Description
1,2	Remote ON-OFF	The unit can turn the output ON/OFF by dry contact between Remote ON/OFF and GND
3,4	GND	



**MECHANICAL SPECIFICATION (Blank/PM/CAN type)**

Case No.277A

Unit:mm

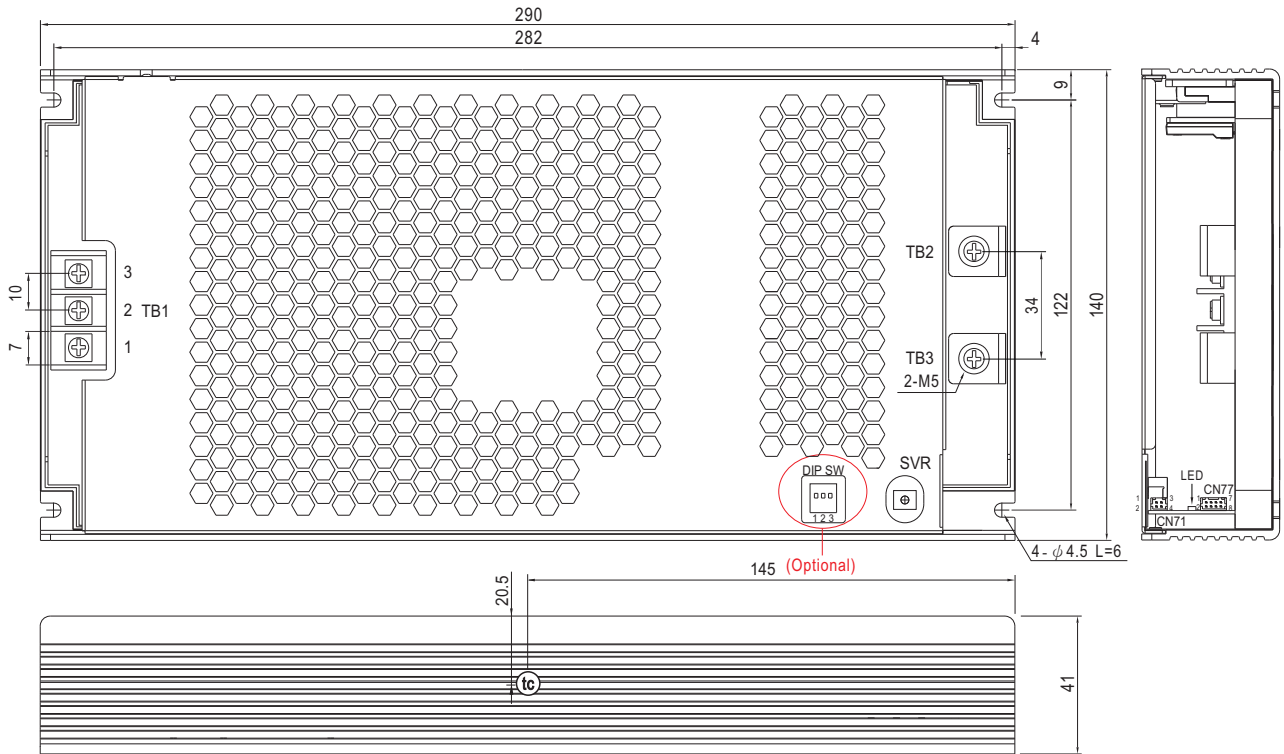

• (tc) : Max. Case Temperature

**AC Input Terminal(TB1) Pin NO. Assignment**

Pin No.	Assignment	Terminal	Max mounting torque
1	AC/L	DG58S	18Kgf-cm
2	AC/N		
3	⊥		

**DC Output Terminal(TB2, TB3) Pin NO. Assignment**

Pin No.	Assignment	Terminal	Max mounting torque
TB2	+V	(MW)	8Kgf-cm
TB3	-V	HS455A	

※DIP SW:

Pin No.	Function	Description
1	A0	PMBus / CANBus interface address switch.
2	A1	
3	A2	

※Control Pin No. Assignment(CN71) : HRS DF11-04DP-2DS or equivalent

※Control Pin No. Assignment(CN77) : HRS DF11-08DP-2DS or equivalent



Mating Housing	HRS DF11-04DS or equivalent
Terminal	HRS DF11-04SC or equivalent



Mating Housing	HRS DF11-08DS or equivalent
Terminal	HRS DF11-08SC or equivalent

Pin No.	Function	Description
1	PV	Connection for output voltage programming.(Note1)
2	PC	Connection for constant current level programming.(Note.1)
3,4	GND (Signal)	Negative output voltage signal.

※Control Pin No. Assignment(CN77) : HRS DF11-04DP-2DS or equivalent

Pin No.	Function	Description
1,2	+12V-AUX	Auxiliary voltage output, 10.8~13.2V, referenced to GND-AUX (pin3 & 4). The maximum load current is 0.4A. This output is not controlled by "Remote ON-OFF".
3,4	GND-AUX	Auxiliary voltage output GND. The signal return is isolated from the output terminals (+V & -V).
5	Remote ON-OFF	The unit can turn the output ON/OFF by dry contact between Remote ON/OFF and 12-AUX.(Note.2) Short (10.8 ~ 13.2V) : Power ON ; Open(-0.5 ~ 0.5V) : Power OFF ; The maximum input voltage is 13.2V
6	DC-OK	Low (-0.5 ~ 0.5V) : When the Vout ≤ 77% ± 6%. High (4.5 ~ 5.5V) : When Vout ≥ 80% ± 6%. The maximum sourcing current is 10mA and only for output.(Note.2)
7	SCL	For PMBus model: Serial Clock used in the PMBus interface. (Note.2)
	CANH	For CANBus model: Data line used in CANBus interface. (Note.2)
8	SDA	For PMBus model: Serial Data used in the PMBus interface. (Note.2)
	CANL	For CANBus model: Data line used in CANBus interface. (Note.2)

Note1: Non-isolated signal, referenced to [GND(signal)].

Note2: Isolated signal, referenced to GND-AUX.

## ■ INSTALLATION

### 1. Operate with additional aluminum plate

In order to meet the "Derating Curve" and the "Static Characteristics", UHP-1500-HV series must be installed onto an aluminum plate (or the cabinet of the same size) on the bottom. The size of the suggested aluminum plate is shown as below. And for optimizing thermal performance, the aluminum plate must have an even and smooth surface (or coated with thermal grease), and UHP-1500-HV series must be firmly mounted at the center of the aluminum plate.

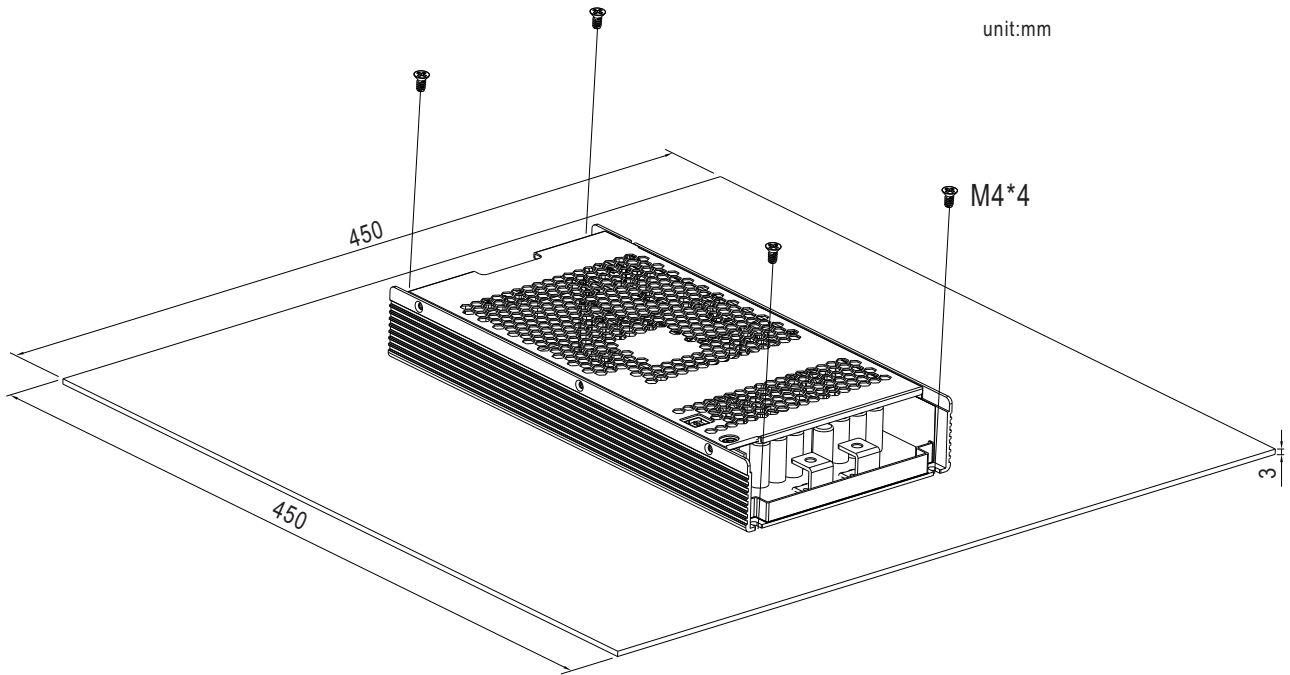

### 2. With 40 CFM forced air

