



### ■ 特性:

- 国际通用全范围交流输入
- 内置主动式PFC功能
- 效率高达91%
- 空载消耗<0.15W
- 能效等级VI
- 符合EU ErP和CoC Version 5
- 保护种类: 短路/过电流/过电压/过温度
- Class II 电源(无接地pin)
- 无风扇设计, 自然风冷
- 5年保固

### ■ 应用:

- 机器人割草机
- 家用电器
- 蓄电池充电
- 在多尘或潮湿环境下使用的一般电子产品

### ■ 描述:

OWA-90E是一个90WAC/DC, class II (无接地pin)具有防潮功能的外置式电源供应器, 塑胶外壳内部灌满硅胶提高散热效果, 同时OWA-90E可达IP67防水等级, 可应用于需要潮湿、防尘的特殊应用, OWA-90E遵照最新能效要求, 并且符合EU Erp和Code of Conduct(CoC) Version 5; 空载损耗小于0.15W, 并且通过EN61558-2-16的认证, 而且选定机型更符合EN60335-1, 可简化如家电类等应用之系统设计。

OWA-90E内建PFC电路, 输入采用通用输入电压范围90VAC~264VAC, 工作效率可达91%, 采用自然风冷, 工作温度范围为-40°C到+70°C。

### ■ 型号编码

**OWA - 90E - 12**

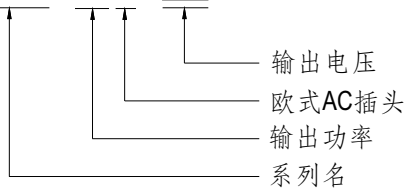



# 90W单组输出防潮适配器

# OWA-90E系列

## 电气规格

型号	OWA-90E-12	OWA-90E-15	OWA-90E-20	OWA-90E-24	OWA-90E-30	OWA-90E-36	OWA-90E-42	OWA-90E-48	OWA-90E-54		
输出	直流电压	12V	15V	20V	24V	30V	36V	42V	48V	54V	
	额定电流	7.5A	6A	4.5A	3.75A	3A	2.5A	2.15A	1.88A	1.67A	
	额定功率	90W	90W	90W	90W	90W	90W	90.3W	90.24W	90.18W	
	纹波与噪声 (最大)备注2	150mVp-p	150mVp-p	150mVp-p	150mVp-p	200mVp-p	200mVp-p	250mVp-p	250mVp-p	350mVp-p	
	电压精度 备注3	±4.0%	±4.0%	±4.0%	±3.0%	±3.0%	±2.0%	±1.0%	±1.0%	±1.0%	
	线性调整率	±0.5%	±0.5%	±0.5%	±0.5%	±0.5%	±0.5%	±0.5%	±0.5%	±0.5%	
	负载调整率	±1.5%	±1.0%	±0.5%	±0.5%	±0.5%	±0.5%	±0.5%	±0.5%	±0.5%	
	启动,上升时间 备注4	500ms, 80m(95%负载) 115VAC / 230VAC									
保持时间(Typ.)	16ms(满载时) 115VAC / 230VAC										
输入	电压范围	90 ~ 264VAC 127 ~ 373VDC									
	频率范围	47 ~ 63Hz									
	功率因数(Typ.)	PF>0.98/115VAC, PF>0.96/230VAC(满载时)									
	效率(Typ.)	89%	90%	90%	90%	90%	91%	91%	91%	91%	
	交流电流(Typ.)	0.95A / 115VAC		0.5A / 230VAC							
	浪涌电流(Typ.)	冷启动60A(在50% Ipeak下测试twidth=550μs)/230VAC									
	漏电流	<0.25mA / 240VAC									
保护	过负载	105~115% 保护模式: 打嗝模式, 负载异常条件移除后可自动恢复									
	短路	打嗝模式, 负载异常条件移除后可自动恢复									
	过电压	15 ~ 17V	17.5 ~ 21V	23 ~ 27V	28 ~ 34V	34 ~ 40V	41 ~ 46V	46 ~ 54V	54 ~ 60V	59 ~ 66V	
		保护模式:关断输出电压, 重启恢复									
	过温度	关断输出电压, 重启恢复									
环境	工作温度	-40~+70°C (请参考"减额曲线")									
	工作湿度	20 ~ 95% RH,无冷凝									
	储存温度、湿度	-40 ~ +80°C, 10 ~ 95% RH									
	温度系数	±0.03% /°C (0~50°C)									
	耐振动	10 ~ 500Hz,5G 12分钟/周期, X、Y、Z轴各72分钟									
安规和电磁兼容	安全规范	EN61558-1,-2-16 listed, EN60335-1 listed(除OWA-90E-42,48,54外),EAC TP TC 004,IP67认证通过									
	耐压	I/P-O/P:3.75KVAC									
	绝缘阻抗	I/P-O/P:100M Ohms / 500VDC / 25°C / 70% RH									
	电磁兼容发射	符合EN55032 (CISPR32) Class B, EN55014-1, EN61000-3-2,-3;EAC TP TC 020									
	电磁兼容抗扰度	符合EN61000-4-2,3,4,5,6,8,11, EN55024, EN55014-2, A级轻工业标准(浪涌L-N : 2KV);EAC TP TC 020									
其它	MTBF	≥ 292.8Khrs MIL-HDBK-217F (25°C)									
	尺寸	171*63*37.5mm									
	包装	0.92Kg; 16pcs/15.7Kg/1.01CUFT									
备注	1. 如未特别说明, 所有规格参数均在输入为230VAC、额定负载、25°C环境温度下进行量测。 2. 纹波和噪声测量方法: 使用一条12"双绞线, 同时终端要并联0.1uf和47uf的电容, 在20MHZ带宽下进行量测。 3. 精度: 包含设定误差、线性调整率和负载调整率。 4. 启动时间是在冷机启动下测得, 频繁的开关机可能使启动时间增长。 ※ 产品免责声明: 详细请参阅 <a href="http://www.meanwell.com.cn/serviceDisclaimer.aspx">http://www.meanwell.com.cn/serviceDisclaimer.aspx</a>										

### ■ 方框图

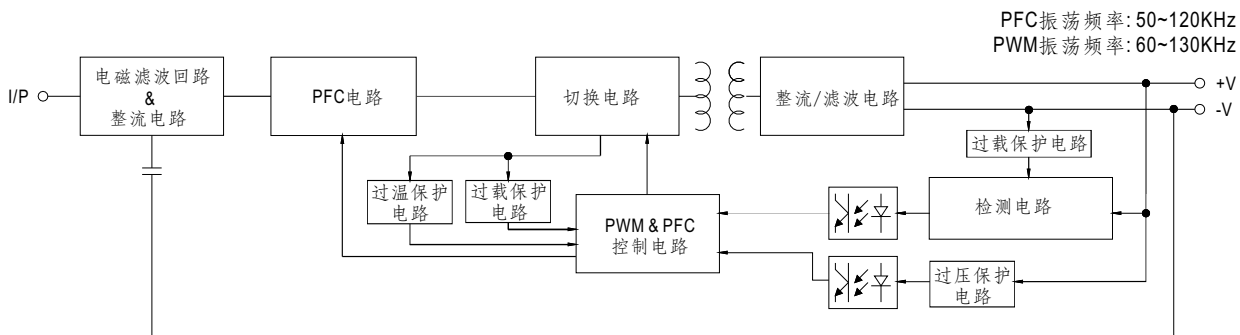

### ■ 减额曲线

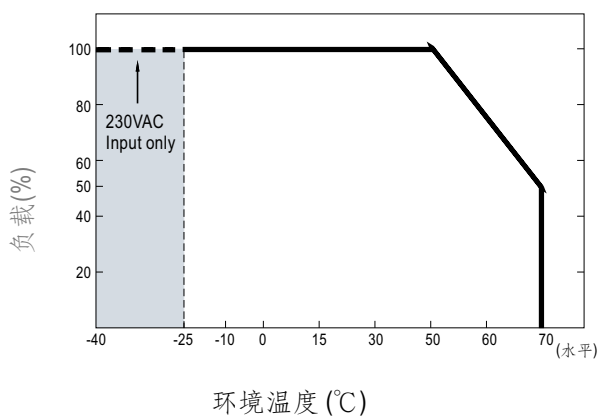

### ■ 静态特性曲线

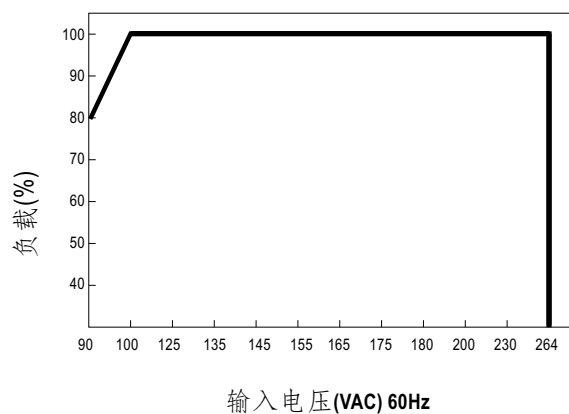

## ■ 机构尺寸

机壳型号: PWM-90P 单位:mm

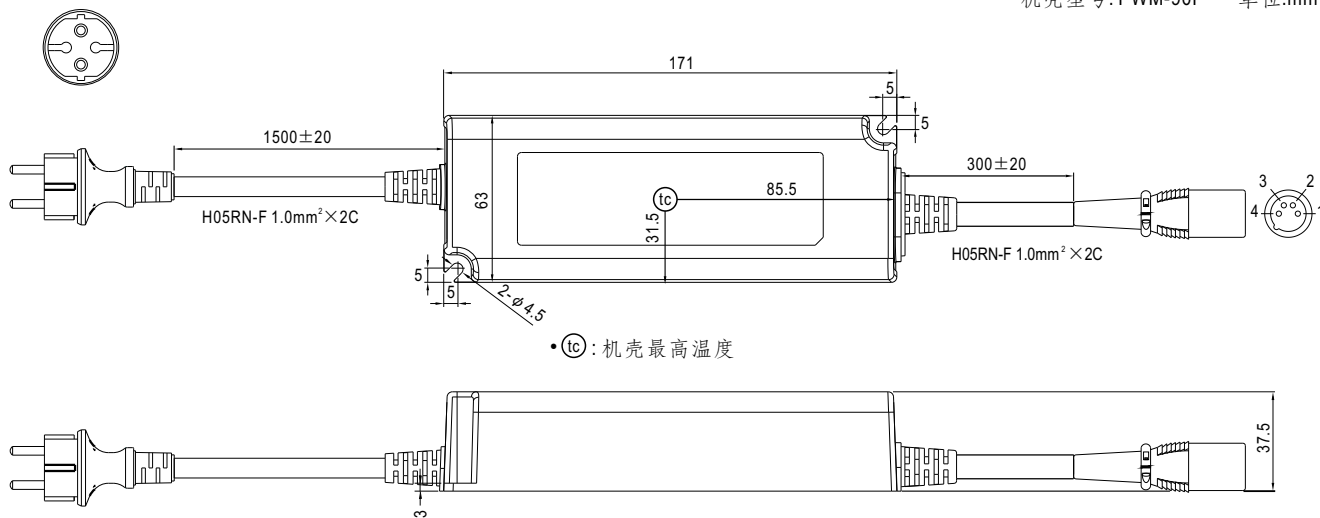





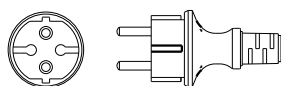



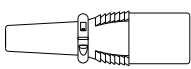

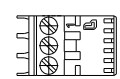

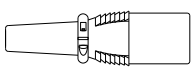

## ■ 输入插头型号

所有标准型: CEE 7/7

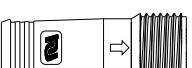

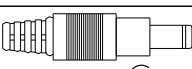
## ■ 输出插头定义

类型	插头描述	插头图	PIN脚号	输出
标准型	XLR 4P, NEUTRIK NC4MX, 或同等级品	 	1,2 3,4	+V -V
可选项	Lumberg 3611 03, 或同等级品	 	1 2 3	+V floated -V
可选项	XLR 3P, NEUTRIK NC3MX, 或同等级品	 	1 2,3	+V -V
可选项	CHOGORI 22002411-01 或同等级品	 	1 2	+V -V
可选项	Unicable UT-D170F4-2P 或同等级品	 	1 2	+V -V
可选项	Unicable UT-D224-2P 或同等级品	 	1 2	+V -V
可选项	2.1φ x 5.5φ x 11 mm, center +, tuning fork type	  Outside ⊖ ⊕ Inside	CENTER	+V

※详情请联系明纬

## ■ 安装手册

请查阅: <http://www.meanwell.com/manual.html>